

FLOORING

STRUCTAflor®

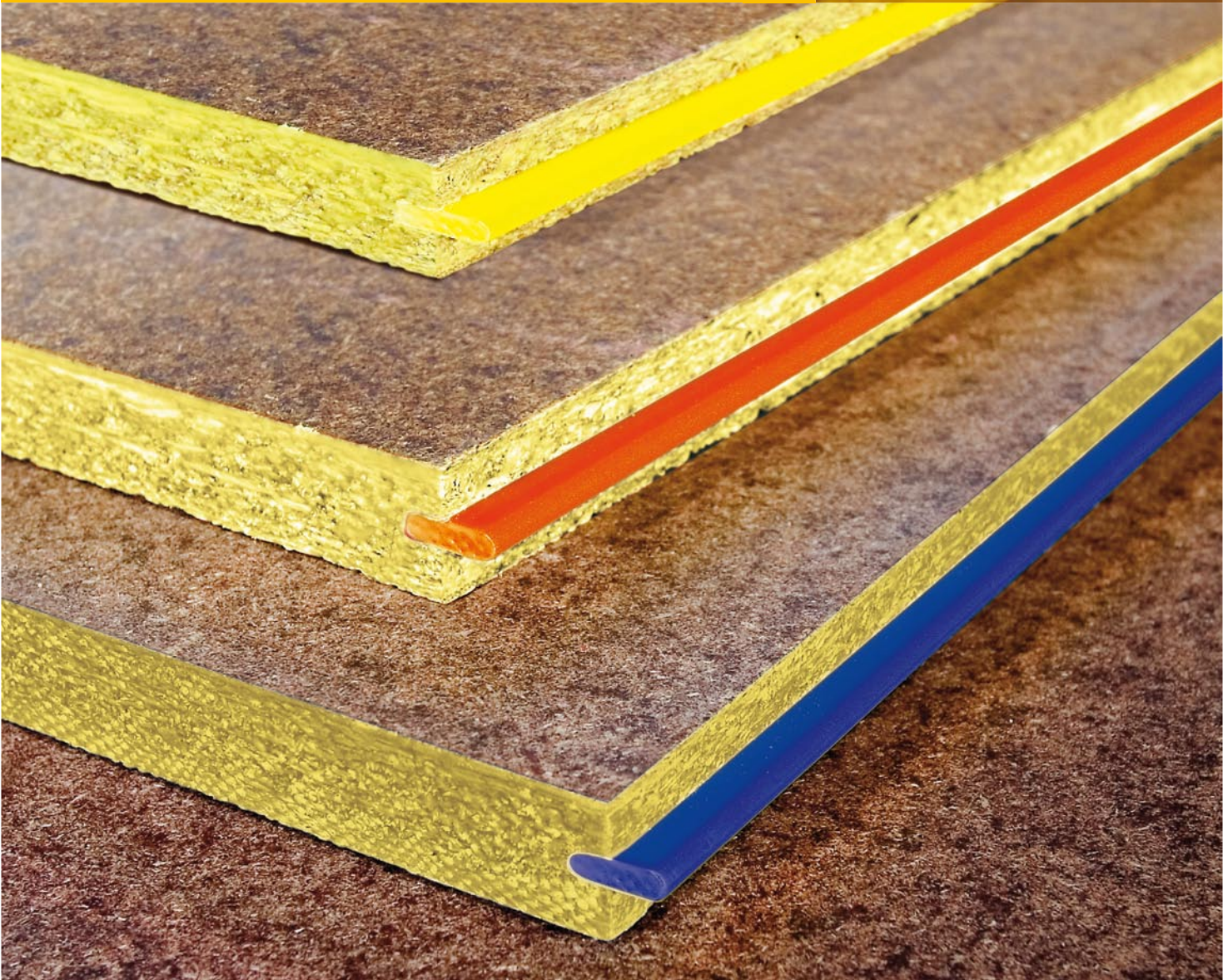

STRUCTAflor
TERMINATOR®

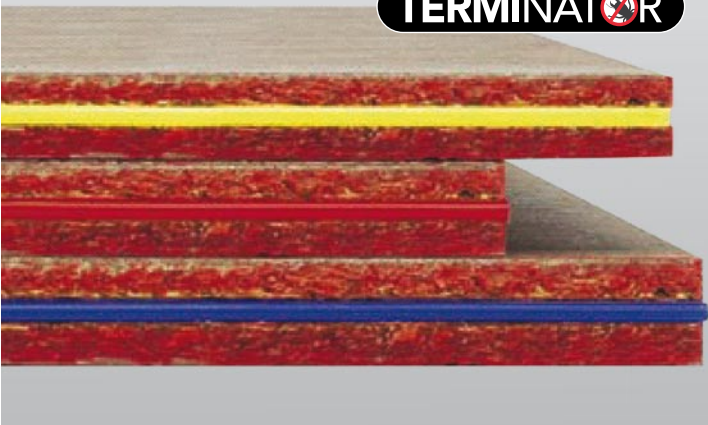

R-flor®





R-flor® Radiant Barrier Flooring



Residential – first (mid) floor



Residential sub-floor

STRUCTAflor® Particleboard Flooring is the number one choice of the majority of Australian builders – making it the most trusted brand in particleboard flooring with an enviable reputation in the building industry.

Since being introduced to the market over 25 years ago, **STRUCTAflor** has continued to be the number one product in its class with proven reliability and durability. Along with its characteristic dark hardwearing surface and edge wax seal, it is easily identified by its distinctive colour coded plastic tongue inserts which denote the **YELLOWtongue®**, **REDtongue®** and **BLUEtongue®** brands.

YELLOWtongue® 

REDtongue® 

BLUEtongue® 

With an extensive range of options, **YELLOWtongue**, **REDtongue** and **BLUEtongue** are ideal for:

- sub-floors
- suspended floors in multi-storey construction

- additions and extensions
- commercial flooring applications

TERMINATOR®

The option of **STRUCTAflor H2 Terminator Resistant Particleboard** flooring provides a cost effective, long term defence against termite damage.

Greenhouse & Environmentally Friendly



STRUCTAflor, and **R-flor** particleboard flooring are made using natural timber grown and harvested from managed, renewable plantation pine.

- No rainforest timbers or endangered species are used
- Timber resource grows on solar energy
- Absorbs and reduces greenhouse gases (CO₂)

The most trusted brands in flooring

- **Hardwearing Durable Surface**
 - Weather protection for up to 3 months
 - Protective film available on R-flor

• Extensive Range

19mm		YELLOWtongue – 450mm max. joist spacing
22mm		REDtongue – 600mm max. joist spacing
25mm		BLUEtongue – Heavy Duty
19mm, 22mm, 25mm		Square Edge

- **25yr Guarantee – Termite Protection***
Available on **STRUCTAflor Terminator** & **R-flor**

TERMINATOR®

25 YEAR GUARANTEE*

*The guarantee is provided by the chemical supplier for the benefit of the property owner. It is a limited and conditional guarantee covering the provision of replacement product used in Australia. The full terms and conditions are available at www.chhwoodproducts.com.au/guarantees

- **Edge Wax Seal**
 - No need to seal un-cut edges
 - Minimises moisture ingress
 - Easy product identification

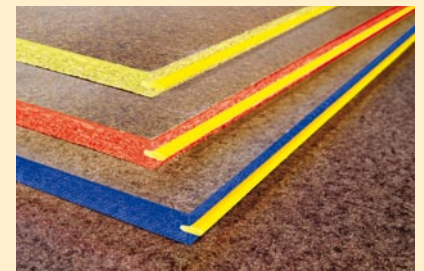

STRUCTAflor – Yellow Wax

STRUCTAflor Terminator – Red Wax

R-flor – Blue Wax

Note: AS1860.2 Particleboard Flooring – Installation recommends that panels be factory sealed against water penetration. Where panels are not factory sealed, and where panels are cut to size on site, the edges should be sealed with adhesive used to bond the panels to the joists.

- **Wax Impregnated Throughout**
 - Moisture protection for cut sheets
- **AWPA Certified to AS/NZS 1860.1 requirements**
- **Market Leader and Innovator**

Energy Efficiency – Problem Solved

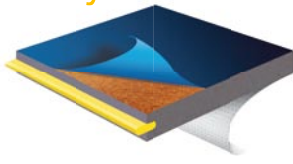

R-flor® Radiant Barrier Flooring

Traditionally constructed lightweight timber floors can be designed to adequately resist the transfer of heat through the floor.

Homes with suspended sub-floors can meet energy requirements with the minimum of fuss.

R-flor Radiant Barrier Flooring is the latest innovation by Carter Holt Harvey, developed to deliver improvements in thermal comfort and energy efficiency achieved by increasing the overall R-value (thermal resistance) of the flooring system.

R-flor Radiant Barrier Particleboard Flooring:

- Increases overall R-Value of floor system
- Improves thermal comfort
- Reduces energy use
- H2 Termite Protection
- Provides fast & easy installation

YELLOWtongue R-flor Total R-Values			
Cavity (see diagram below)	Floor Covering	Enclosed Sub-floor	Unenclosed Sub-floor
Blocked (disconnected)	Bare	1.75	1.16
	Carpeted	2.16	1.57
Unblocked (connected)	Bare	1.36	1.16
	Carpeted	1.77	1.57

- Notes:
1. R-Values for heat flow down, standard brick veneer construction. Typical suburban location, floor height 0.5m. h2/OIST® 240mm joist. Ground floor area/perimeter: 180m²/72m. Clay soil type.
 2. R-Values calculated in accordance with the relevant provisions of Australian Standard AS/NZS 4859.1-2002. Materials for the thermal insulation of buildings Part 1: General criteria and technical provisions and the International Standards Organisation standard ISO 13370-2005. Thermal performance of buildings - Heat transfer via the ground - Calculation Methods are used as the methodology for determining the R-Value of suspended floors.
 3. Assumption for carpet: 10mm carpet, 10mm underlay both with a conductivity of 0.05 W/m2K.

Cavity Detail

Disconnected (Blocked) Cavity

To prevent ventilation between sub-floor space and wall cavity.

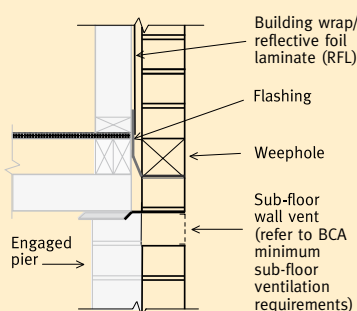

How R-flor Works

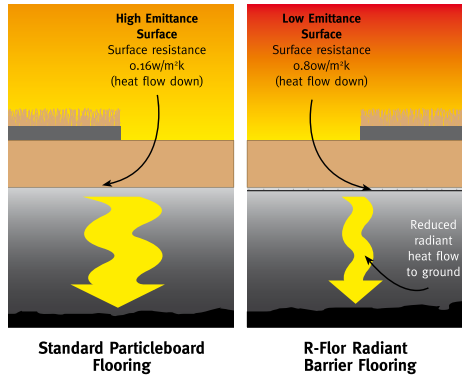

Economical & Versatile

STRUCTAflor and R-flor flooring systems provide significant cost savings through their economy and lighter construction. They reduce foundation costs and reduce construction times since only dry trades are used.

Timber sub-floor and mid-floor systems provide significant advantages including:

- Reduced site impact – reduced need for bulk site excavation, earth retaining walls and special drainage
- Easier construction for split level and double storey designs
- Simple, economical installation of central heating, plumbing and electrical wiring
- Greater adaptability to later extensions or alterations
- Underfloor storage space
- Keeping building occupants high & dry
- Flexibility to choose from a variety of floor coverings
- Fast and easy installation

Australian Termite Risk Zones



R-flor and STRUCTAflor Terminator Termite Resistant Particleboard Flooring conform to H2 level treatment requirements and can be used throughout Australia.

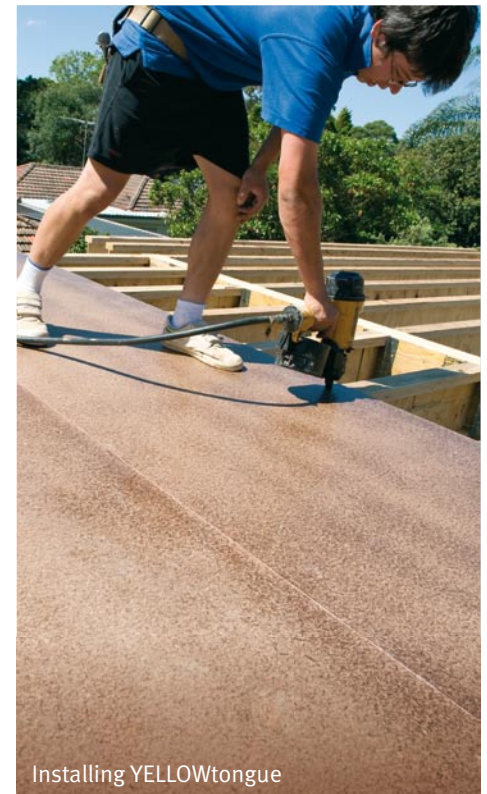

Installing YELLOWtongue

Product Range

Size Coverage	STRUCTAflor		STRUCTAflor Terminator		R-flor	
	900x3600mm 3.24m ²	600x3600mm 3.24m ²	900x3600mm 3.24m ²	600x3600mm 2.16m ²	900x3600mm 3.24m ²	900x3600mm 3.24m ² (BARE)
YELLOWtongue 19mm Domestic Flooring 450mm Joist Spacing	✓	✓	✓		✓	✓
REDtongue 22mm Domestic Flooring 600mm Joist Spacing	✓	✓	✓		✓	✓
BLUETongue 25mm Heavy Duty Commercial Flooring		✓		✓	✓†	✓†

Square edge flooring also available. † 600mm x 3600mm sheet size. BARE = without protective surface film.

Installation Details (900mm wide sheet)

- 300mm centres (maximum) – body of sheet
- 150mm centres (maximum) – sheet edges
- 25mm from T&G edges
- 10mm from square edges

End joints between panels should be staggered.

Refer to the **STRUCTA** for Installation Manual for further information.

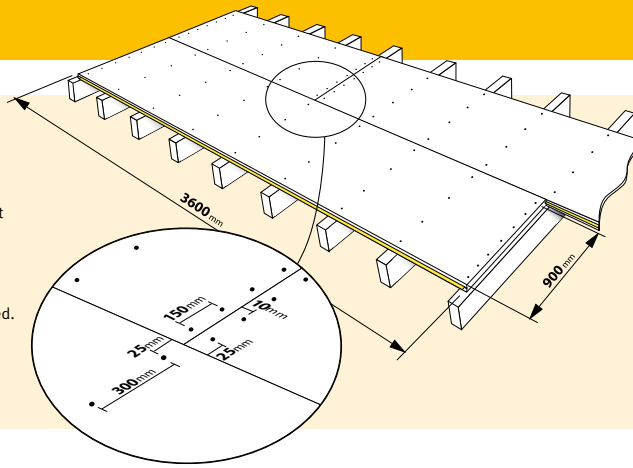

Minimum nail size & length combinations

NAILS Nail Type	Joist Type	Flooring Thickness (mm)	Nail Size (mm)
Hand-driven	Hardwood & cypress pine	19.22	50 x 2.80
		25	65 x 3.75
	Softwood	19.22	65 x 2.80
		25	75 x 3.75
Machine-driven, D-head, round-head or finished-head	Hardwood & cypress pine	19.22	50 x 2.50
		25	65 x 2.5*
	Softwood	19.22	65 x 2.5*
		25	75 x 2.5*

*Available in D-head or round-head only.
Tables extracted from AS1860.2

Installation Methods

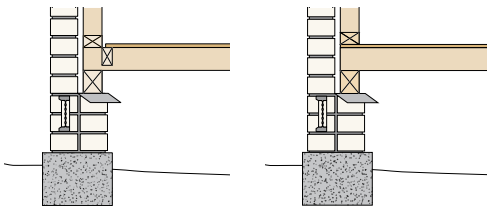

Fitted Construction

For installation after walls have been erected.

Platform Construction

This installation method provides a working platform for wall and roof frame erection and contributes to time and cost savings.

Platform Exposure

The product may be exposed to the weather for up to three months. However, it is **always advisable to enclose the building as soon as possible after laying the floor.**

Minor swelling that may result due to prolonged exposure to weathering (resulting from the hygro-expansivity of particleboard) can be removed by sanding following the enclosure of the building. The depth of material removed shall not exceed the following:

Ground Clearance

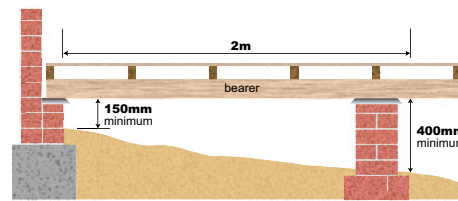

BCA Minimum underfloor clearance requirements

The BCA (and AS3660.1: Termite Management) requires a minimum ground clearance of 400mm minimum from ground surface to underside of bearer where termite inspection is required. On sloping sites, 400mm clearance may be reduced to 150mm within 2m of external walls.

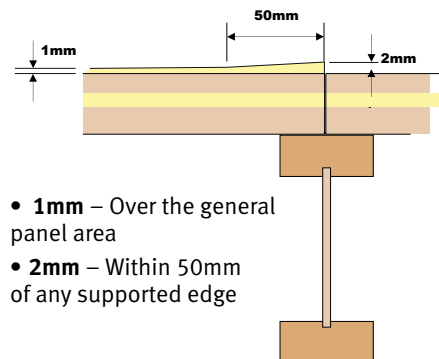

AS1860.2 Sanding Provision

- **1mm** – Over the general panel area
- **2mm** – Within 50mm of any supported edge

Minimum screw size & length combinations

SCREWS Joist Material	Flooring Thickness (mm)	Screw Type & Size
Timber	19 & 22	No. 10 x 50 mm twin-thread, self-drilling wood screw
	25	No. 14 x 65mm twin-thread, self drilling wood screw
Steel	19, 22 & 25	No. 9 or 10 x 45mm countersunk self-embedding head, self-drilling
<p>Fixing to steel & timber I-beam joists</p> <p>NOTE: AS1860.2 recommends that if particleboard flooring is fixed to:</p> <ul style="list-style-type: none"> • Timber I-beam joists – screws (not nails) should be used. • Steel joists – No.9 or 10 x 45mm screws are recommended 		



Available from:

